User Manual for the *Profile Probe*

type *PR2*



PR2-UM-5.0

Delta-T Devices Ltd

Notices

Copyright

All rights reserved. Under the copyright laws, this manual may not be copied, in whole or in part, without the written consent of Delta-T Devices Ltd. Under the law, copying includes translation into another language.

Copyright © 2016, Delta-T Devices Ltd.

Patent

The *Profile Probe* is protected by the following patents:

US7944220B2

EP1836483B1

AU2005315407B2

CN101080631(B)

CE conformity

The *Profile Probe* type PR2 conforms to EC regulations regarding electromagnetic emissions and susceptibility when used according to the instructions contained within this user manual, and is CE marked by Delta-T Devices Ltd.

Design changes

Delta-T Devices Ltd reserves the right to change the designs and specifications of its products at any time without prior notice.

User Manual Version: PR2-UM-5 Oct 2016

Delta-T Devices Ltd.
130, Low Road
Burwell
CAMBRIDGE CB25 0EJ
UK

Tel: +44 1638 742922
Fax: +44 1638 743155
E-mail: sales@delta-t.co.uk
Web: www.delta-t.co.uk

Contents

	1
Introduction	4
Description	4
Parts list	6
Care and safety instructions	7
Routine maintenance	7
PR2 Cleaning and Chemical Avoidance Instructions	8
How the <i>Profile Probe</i> works	9
Operation	10
Preparation for reading	10
Insert the <i>Profile Probe</i>	12
Portable monitoring	14
Record readings with a data logger	15
Calibration	21
Conversion to soil moisture	23
Reading accuracy	26
Troubleshooting	28
Problems	28
Technical reference	30
Specifications	30
Performance	31
Definitions	33
References	35
Technical Support	36
Soil-specific calibration	38
Laboratory calibration non-clay soils	39
Laboratory calibration for clay soils	42
Field calibration	45
Index	48

Introduction

Description

The *Profile Probe* measures soil moisture at different depths within the soil profile. It consists of a sealed polycarbonate rod, ~25mm diameter, with electronic sensors (seen as pairs of stainless steel rings) arranged at fixed intervals along its length.

When taking a reading, the probe is inserted into an access tube. These are specially constructed thin-wall tubes, which maximise the penetration of the electromagnetic field into the surrounding soil.

Short and long versions of the PR2 are available, with 4 or 6 sensors along the length. These have either analogue outputs (types PR2/4 and PR2/6) or a serial SDI-12 output (types PR2/4-SDI-12 and PR2/6-SDI-12).

This manual is for analogue PR2s. Each sensor gives a voltage output which is converted into soil moisture using the supplied general soil calibrations. The probe can also be calibrated for specific soils.

Advantages

- Can be used for portable readings from many access tubes or for long-term monitoring of one access tube.
- Fully sealed and robust.
- High accuracy: $\pm 4\%$.
- Easy installation with minimal soil disturbance.
- Large sampling volume ~ 1.0 litres at each profile depth.
- Simple analogue output, 0 to ~1.0 Volts
- Works reliably even in saline soils.

Sensor Depths

PR2/4 sensors are at 10, 20, 30 and 40 cm

PR2/6 sensors are at 10, 20, 30, 40, 60 and 100 cm



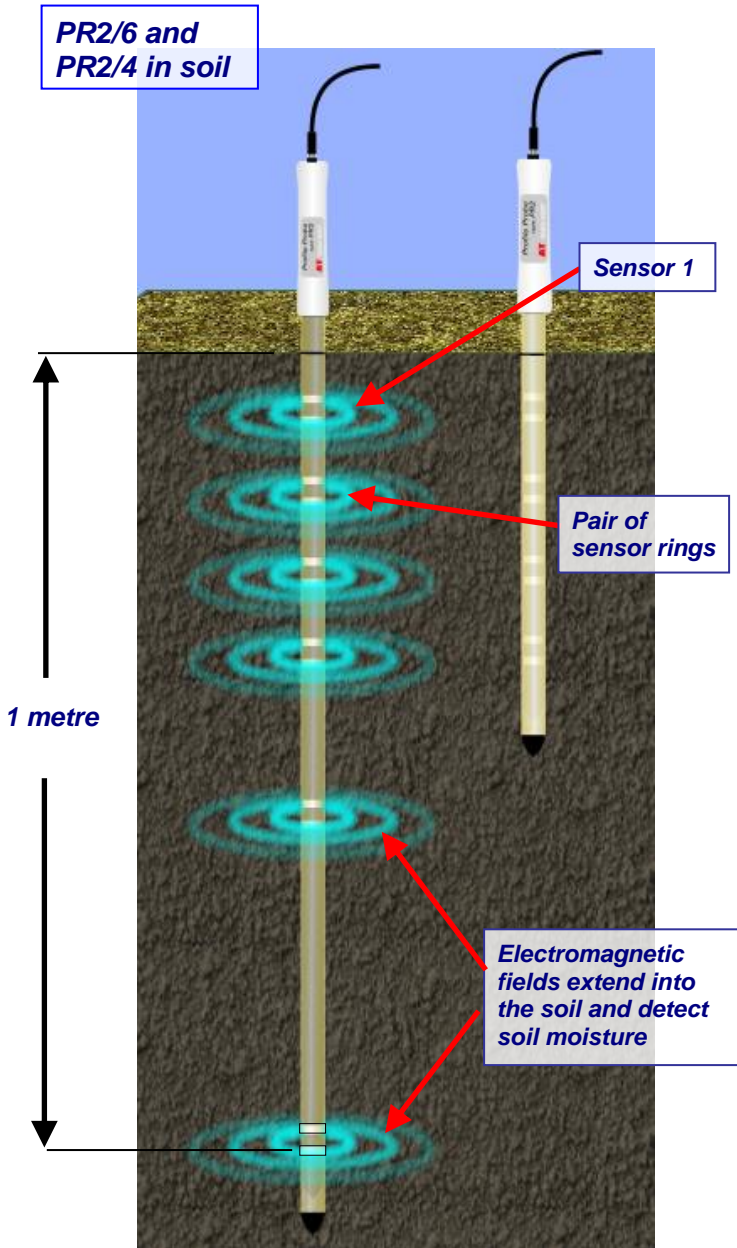

Each sensor has a pair of rings 10 cm apart vertically. The depths given are from the centre of the lower ring to a black ring marked near the top of the access tube (see next page).

See also **Field Sensitivity** on page 31.

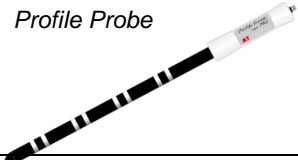
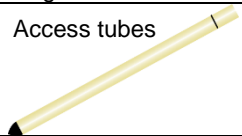

Parts list

Your consignment may have the following parts:

Part	Sales Code	Description
 Profile Probe	PR2/4 or PR2/6	PR2/4 with 4 sensors (as shown) or PR2/6 with 6 sensors. Both supplied in protective tube, with spare o-rings and centring springs
Access tube spacer	SPA1	Corrects PR2 depths if access tube is mounted flush with soil surface
Spares kit	PR2-SP	
Cleaning kit	AT-CR1	Cleans access tubes.
Bag	PR-CB2	Carrying bag for PR2
 Access tubes	ATS1 or ATL1	Short or long fibreglass tubes suitable for PR2/4 or PR2/6, including cap, bung and collar.
Augering equipment	-	See Augering Manual
Insertion equipment	-	See Augering Manual
Extraction equipment	-	See Augering Manual
 Meter	HH2	Moisture meter plus accessories
 Data logger	GP2, DL6, or DL2e	GP2: 12 channel DL6: 6 channel DL2e: up to 60 channels Data loggers optimised for use with PR2,
 Expansion Lid	GP2-P2-LID	GP2 lid with 2 PR2 sockets, use with PRC/M12-05 cables
Cables	PRC/d-HH2	1.5m to HH2
	PRC/M12-05	5m to DL6 or GP2
	PRC/w-05	5m to DL2e or other loggers
	EXT/8w-05 EXT/8w -10 EXT/8w -25	5m, 10m and 25m extension cables (PRC/M12-05 and EXT/M12-10 are identical)

Care and safety instructions

- **Keep your PR2 in its protection tube** and fit the connector cap when the probe is not in use. The *Profile Probe* should be stored in a dry environment (definitely non-condensing), and protected from sharp blows
- **Earth yourself on the metal connector** before touching the detector rings to avoid any possibility of damage by electrostatic discharge.
- **Don't lay the PR2 in a puddle** because water may creep under the rings – if you suspect this has happened warm gently (< 50°C) for 24 hours.
- **Lay as much of the cable as possible along the surface of the soil** when taking a reading in order to minimise any electrical interference with other equipment.
- Twist when inserting the PR2 to ensure the O-ring in the handle seals properly against the wall of the access tube.

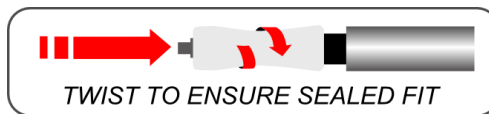

See also the video <https://youtu.be/KvZC2-xYDL8>

Routine maintenance

- **Periodically examine the o-rings and centring springs.** They should be kept clean, and if they show any signs of damage, replace them. Pay attention particularly to the lowest centring spring when inserting the PR2 into an access tube – a gentle twisting action helps.
- **The *Profile Probe* should be periodically recalibrated.** You should run a simple annual check on the calibration (see the **Troubleshooting** section) and contact your local Delta-T representative if there is a problem. Otherwise the PR2 should be returned for routine re-calibration every 2 years.

PR2 Cleaning and Chemical Avoidance Instructions





The PR2 shaft is made of polycarbonate plastic which is an exceptionally strong material, and it can withstand bending forces far in excess of anything likely to be encountered in practice. However, polycarbonate can develop stress cracking when exposed to certain chemicals. Such stress cracking greatly weakens the polycarbonate and may lead to brittle fracture of the shaft, even at very low stresses.

It is important to follow these guidelines. Failure to observe these precautions can damage the probe and may invalidate the warranty.

- Clean the probe in use if necessary by wiping with damp plain paper towels.
- Use only clean water to damp the paper. Do not use chemicals or cleaning agents of any sort in the water.
- Never use any chemical solvents or cleaners on the probe, or near to it. Avoid strong chemical vapours, especially during probe storage.
- Do not immerse the probe in water. If this happens, allow the probe to dry in warm air for at least 24 hours.
- Make sure the probe is thoroughly dry before storing it in the protection tube.

How the *Profile Probe* works

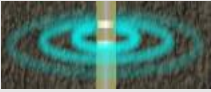
Before you rush out and hammer your access tubes into the soil, it will help to understand a little about how the *Profile Probe* works:

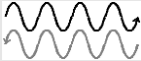
	When power is applied to the <i>Profile Probe</i> ...
	...it creates a 100MHz signal (similar to FM radio).
	The signal is applied to pairs of stainless steel rings....
	... which transmit an electromagnetic field extending about 100mm into the soil. The field passes easily through the access tube walls, but less easily through any air gaps.
	The water content of the soil surrounding the rings...
ϵ	...dominates its permittivity . (A measure of a material's response to polarisation in an electromagnetic field. Water has a permittivity ≈ 81 , compared to soil ≈ 4 and air ≈ 1)
	The permittivity of the soil has a strong influence on the applied field...
V_{out}	...resulting in a stable voltage output that...
Soil Moisture 22 %	...acts as a simple, sensitive measure of soil moisture content .

Operation

Preparation for reading

Access tubes

The *Profile Probe* must be used within an access tube. The process of Augering holes and installing access tubes is described in the Augering Manual.

Equipment

You may require the following equipment for a site visit:

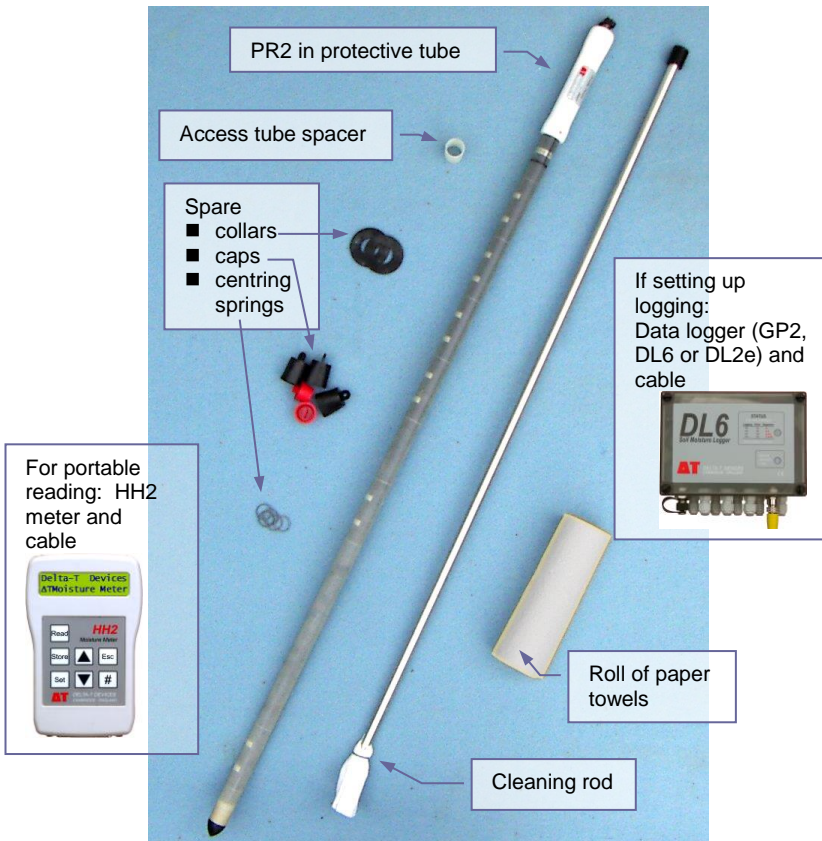

Install access tube(s)

The accuracy of your results will be critically dependent on how well the access tubes are installed

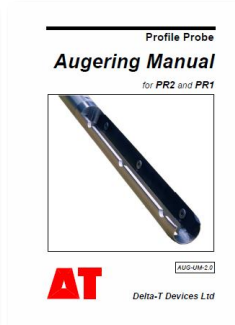
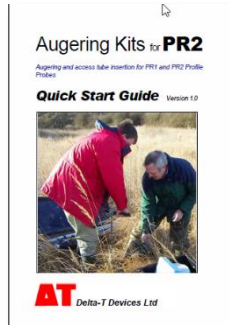
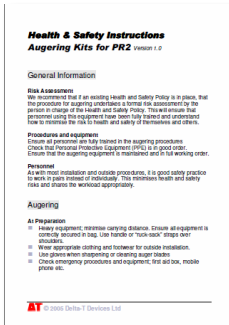

Please refer to the following

1. Augering Health and Safety Sheet
2. Augering Kit for PR2 Quick Start
3. Augering Manual

See also the Augering tutorial video at

<https://youtu.be/KvZC2-xYDL8>



Insert the *Profile Probe*

■ Remove the tube cap and check for damp

If the access tube has been left empty for several weeks, check for condensation by threading a paper towel into the slot in the cleaning rod and pushing this to the bottom of the tube. If any water is present, dry the tube thoroughly before inserting the PR2.

■ Check the centring springs

Remove the PR2 from its protective tube.

The *Profile Probe* is fitted with centring springs so that the probe is correctly centred within an access tube. They *must* be fitted and working properly for the probe to take accurate readings. Each centring spring (coiled spring) sits on top of an O-ring (see illustration).

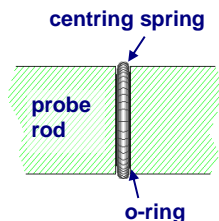

■ Fit spacer (if required)

If your access tube has been installed flush with the soil surface, you will need to fit the access tube spacer (SPA1). Slide the spacer over the tip of the probe and push all the way up past the top o-ring.

Note: the access tube is not water proof if this is used

■ Insert the *Profile Probe*

Take care as the first centring spring is pushed into the tube not to pinch the spring unevenly against the side of the tube. Use a slight twisting motion to get past the last rubber O-ring which is just below the handle.

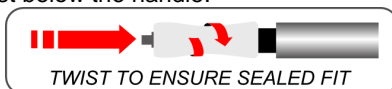

Ensure the *Profile Probe* is pushed all the way down over this rubber O-ring in order to seal it into the access tube.

■ Align the probe

The probe should be aligned consistently each time it is inserted, using the alignment marks on the access tube and the label on probe handle.

To maximise the sampling at each location, take the average of three readings at each location, with the tube rotated through

120° each time – the three small screw heads can be used for as markers for this.

Once fully inserted into an access tube and oriented as outlined above, the PR2 is ready for readings with an HH2 meter or for attaching to a data logger for long term automatic monitoring.

The use of these instruments is described next.

Portable monitoring

■ Set up the HH2 meter

Connect the *Profile Probe* to your HH2 using the supplied **PRC/d-HH2** cable

Press **Esc** to turn the meter on, and if necessary press again until it displays:

Delta-T Devices
ΔTmoisture Meter



Make sure the meter is set to read from a PR2:

- Press **Set** and scroll down to the **Device** option.
- Press **Set** again and scroll down to:

Device:
◆ PR2

- Press **Set** to confirm this choice.

If you intend to store readings, you may find it useful to define each reading by setting a plot label and sample number – accessed by pressing **Set** and scrolling to the **Data** option.

See Calibration section for advice on setting **Soil Type** and **Soil Set-Up**.

For other options, refer to the HH2 User Manual.

■ Taking readings

Insert the *Profile Probe* into an access tube.

Press **Read** to take a reading - it takes about 3 seconds.

Press the arrow keys to view readings from other depths. You can choose different units from the **Display** option.

PR2 **Store?**
22.7%vol ◆ 100mm

Press **Store** to save or **Esc** to discard the reading.

If you want to maximise the sampling volume, take 2 further readings with the probe rotated through 120° each time.

Remove the PR2, replace the access tube cap and move on to a new site....

■ Viewing stored readings

If you have saved data, connect the HH2 to your PC and run HH2Read to retrieve the readings.



Record readings with a data logger

The *Profile Probe* has been designed to make its use with data loggers straightforward. It is particularly simple to use with the GP2, DL6 and DL2e data loggers.

Up to 100 m of cable can be used between logger and PR2, but be aware that the minimum power supply voltage required by the sensor is 5.5 V. This is OK for a 2 m cable but at the end of a 100 m the minimum supply voltage needs to be raised to 7.5 V.

Data Logger options for Profile Probes

Logger	PR2/4	PR2/6	Notes
DL6	1	1	Profile probe can be instantly connected via dedicated socket and cable PRC/M12-05
GP2	3	2	With the GP2-P2-LID option up to 2 PR2s can be instantly connected to dedicated analogue input sockets. A third probe can be connected using screw terminals.
DL2e	3 to 15*	2 to 10*	Basic DL2e logs 3 PR2/4s or 2 PR2/6s. More can be connected via additional LAC1 input cards

* Subject to power switching requirements. Do not exceed 1200mA in either of the two DL2e relays. The standard analogue PR2/4s take 80 mA and the PR2/6s take 120 mA.

Note: GP2 loggers can take up to 50 SDI12 PR2/6s or up to 60 SDI12 PR2/4s. (This limitation is imposed by the GP2 logger program which can process a total of 300 different measurements).

DL6 connection and configuration



You need a PC running DeltaLINK connected to a DL6 via the 4-pin M12 connector on the DL6 using cables DL6-RS232 and USB-RS232. Connect the PR2 to the DL6 via cable PRC/M12-05.

This 8-way M12-M12 cable connects directly to the DL6¹. (If you use this you don't use the screw terminals and so don't need to know the wiring colour codes for the individual sensor channels.)

Extension cables can be added as required up to 100m.

■ Configure the DL6

In DeltaLINK establish a connection with the logger.

- 1) Select **Program**
- 2) Select **Change**
- 3) Right click channel 1
- 4) Select **PR2/4** or **PR2/6** from the drop down menu.
- 5) The default soil type is **mineral**. To change this, right click on a channel and, from the drop-down menu, either select 5a **Organic**, or 5b **Edit** and enter soil-specific calibrations.
- 6) Click **Apply** to send the program to the logger.
- 7) Select **Sensors, Read Now** to check the PR2 is working.

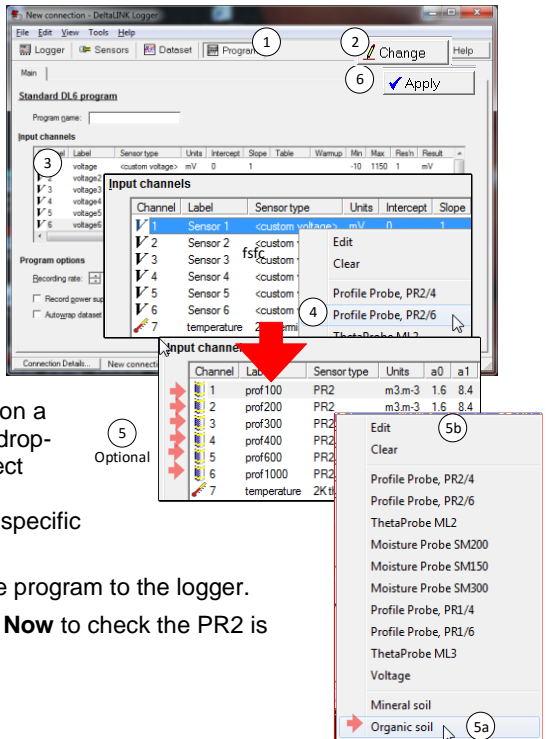

■ Start logging

When ready select the **Logger** window and **Start** ...

...later when you want to collect the data, connect to the DL6 and select the **Dataset** window from which you can retrieve and display all stored readings.

See also the DL6 Quick Start Guide.

¹ If instead you use to PRC/w-o5 5m PR2 to bare wire cable you will need to know the wiring colour code - described below for the DL2e Logger.

DL2e connection and configuration

The *Profile Probe* is fitted with a screened 8-way connector.

When used with a DL2e this should be connected using the PRC/w-05 cable, which provides the following connections.

Cable Colour	Function	Depth mm	Notes	
Red	Power V+		5-15V DC, PR2/4 80mA, PR2/6 120 mA. Power 0V is cable screen.	
Black	Power 0V			
Green	V- 1	100	Common signal output	
	V- 2	200		
	V- 3	300		
	V- 4	400		
	V- 5	600		Not connected for PR2/4.
	V- 6	1000		Not connected for PR2/4
Yellow	V+ 1	100	Signal +	
Grey	V+ 2	200		
Brown	V+ 3	300		
White	V+ 4	400		
Blue	V+ 5	600	Not connected for PR2/4.	
Pink	V+ 6	1000	Not connected for PR2/4	

Notes:

1. The cable screen serves as the power return and is given black insulation.
 2. Do not connect the Power 0V and Signal common at the logger. This will create reading errors.
-

PR2- DL2e Wiring

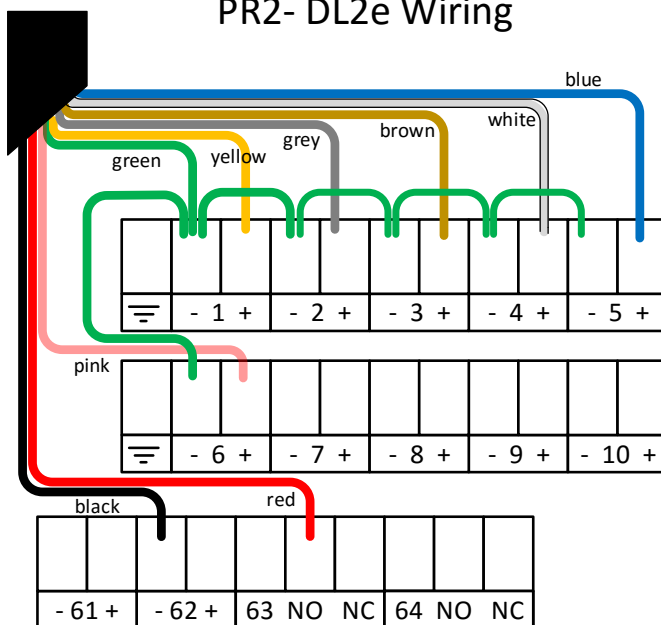

This diagram shows the connections for a PR2/6 connected to channels 1 to 6 of a DL2e in differential mode, and powered through the logger's internal power supply.

(If using channel 1 be sure to switch off the thermistor)

Further details can be found in your Ls2Win installation. The DL2 Program Editor contains on-line help and an application note on each sensor type.

DL2e Sensor Types Codes in Ls2Win

Four DL2e sensor codes are supplied for the PR2:

P2M provides a conversion from mVolts to soil water content (in $m^3.m^{-3}$) suitable for general mineral soils.

P2O converts to $m^3.m^{-3}$ for general organic soils.

P2C converts to %vol for general mineral soils.

P2D converts to %vol for general organic soils.

Note: All DL2e data in $m^3.m^{-3}$ units is restricted to 0.01 $m^3.m^{-3}$ resolution. The P2C and P2D codes using %vol show much better resolution, and are preferred.

Power supply

Profile Probes types PR2 require 5.5 to 15 VDC power. Power can be applied continuously, or via a warm-up relay for greater economy of power consumption.

You can power *Profile Probes* directly using DL2e, GP2 or DL6 internal batteries. However, if several probes are to be used, or if the data logger has to supply significant power to other sensors or accessories, we recommend powering the data logger and sensors from an external power supply.

The DL2e has two warm-up relay-controlled outputs. Each relay can typically power up to 12 PR2/4 or 8 PR2/6 *Profile Probes*.

Note: *For best economy the Profile Probe should be powered up using a 1 second warm-up time.*

GP2 Logger Controller

Please refer to the GP2 Data Logger Controller User Manual and DeltaLINK Sensor Library Help for wiring and programming instructions.

The GP2 User Manual also describes use of the GP2-P2-LID.

Other data loggers

The connections and power requirements will usually be the same as for the DL2e.

If you simply want to log the sensor voltages directly, they can be treated as differential voltage sources of range 0 – 1.1 V DC, and the data logger should be configured accordingly.

Warning: *we recommend connecting Profile Probes as differential voltage sensors because they are **powered** sensors. You can measure Profile Probes single-ended, but this will introduce an additional measurement error that depends mainly on the length of your cable. It may also have undesirable side effects on the apparent reading from other sensors attached to the data logger.*

You can either convert the data to soil moisture units after logging, or program your data logger to convert the output automatically before logging the data, using the information supplied in the **Conversion to Soil Moisture** section.

Calibration

The *Profile Probe* detects soil moisture by responding to the permittivity (ϵ') of the damp soil (see illustration on page 9) – or more accurately to the refractive index of the damp soil, which is \sim equivalent to $\sqrt{\epsilon}$.

As a result, the performance of the Profile Probe is best understood if it is split into these two stages:

Soil calibration: soil moisture (θ) determines $\sqrt{\epsilon}$

Profile Probe response: $\sqrt{\epsilon}$ determines PR2 output (Volts)

Soil calibration

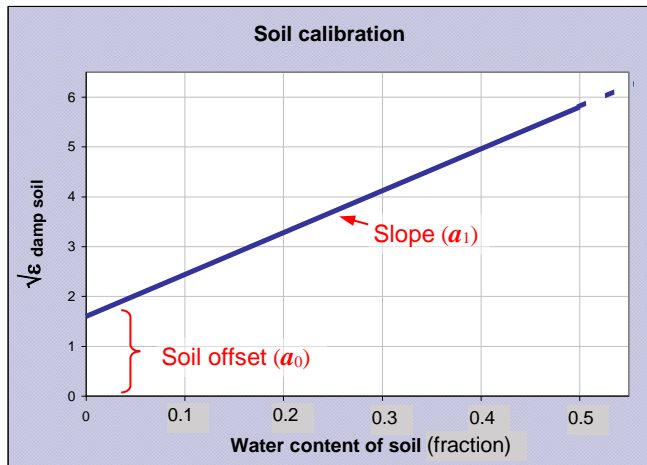

This method of detection is very sensitive and accurate, but of course soils can be enormously different one from another.

The soil offset and the slope of the line in the graph above both depend slightly on soil type, varying with density, clay content, organic matter etc.

This can be usefully summed up in a simple equation describing the relationship between $\sqrt{\epsilon}$ and the soil water content, θ , which contains two parameters (a_0 and a_1) that reflect the influence of the soil:

$$\sqrt{\epsilon} = a_0 + a_1 \times \theta \quad [1]$$

The accuracy of your *Profile Probe* readings can be improved if you choose appropriate values for a_0 and a_1 . This is usually very simple...

Note: in equation 1 the water content θ is expressed as a volume fraction $m^3.m^{-3}$ not %

Generalised calibrations

Most soils can be characterised simply by choosing one of the two generalised calibrations we supply, one for mineral soils (predominantly sand, silt or clay) and one for organic soils (with a very high organic matter content).

	a_0	a_1
Mineral soils	1.6	8.4
Organic soils	1.3	7.7

These values have been used to generate the slope and offset conversions and linearisation tables in the **Conversion to soil moisture** section.

Soil-specific calibration

If it is important to work to higher accuracy, you may choose to carry out a soil-specific calibration, but please bear this in mind:

For normal agricultural soils, if you use one of the generalised calibrations, you can expect typical errors of $\sim \pm 0.06 \text{ m}^3 \cdot \text{m}^{-3}$, including installation and sampling errors.

If instead you use a soil-specific calibration, you can expect typical errors of $\sim \pm 0.05 \text{ m}^3 \cdot \text{m}^{-3}$.

As a guideline, we suggest that you **only** need to do a soil-specific calibration if one of the following applies:

- *Your soil is heavy clay, highly organic, or in some respect “extreme”.*
- *You are working to high levels of accuracy, or you need a controlled error figure rather than a “typical” error figure.*

and the following do **not** apply

- *Your soil is very stony (insertion errors are likely to outweigh the calibration errors)*
- *your soil cracks when it dries (again measurement errors are likely to be higher than calibration errors)*

The procedure for carrying out a soil-specific calibration is detailed in Appendix A.

Profile Probe response

All Profile Probes have the same dielectric performance:

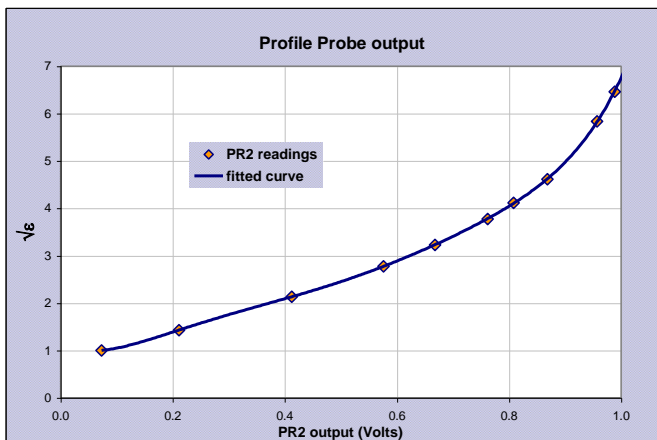

This relationship can be fitted very precisely up to $\sim 0.5 \text{ m}^3.\text{m}^{-3}$ by the following polynomial:

$$\sqrt{\epsilon} = 1.125 - 5.53V + 67.17V^2 - 234.42V^3 + 413.56V^4 - 356.68V^5 + 121.53V^6 \quad [2]$$

and can be approximated by the following linear relationship:

$$\sqrt{\epsilon} = 0.37 + 4.43V \quad \text{up to } 0.3 \text{ m}^3.\text{m}^{-3} \quad [3]$$

Conversion to soil moisture

Profile Probes can either be used to give instantaneous readings of soil moisture using a hand-held meter, or they can be connected to a data logger to record moisture data over time.

In either case you will probably want to configure the meter or data logger to convert the *Profile Probe* output to soil moisture content. Three data conversion methods can be used:

- ◆ **polynomial** conversion
- ◆ **linear** conversion (slope and offset)
- ◆ **linearisation table** conversion

Polynomial conversion

Combining the *Soil calibration* and *Profile Probe response* steps, the conversion equation becomes:

$$\theta_v = \frac{[1.125 - 5.53V + 67.17V^2 - 234.42V^3 + 413.56V^4 - 356.68V^5 + 121.53V^6] - a_0}{a_1} \text{ m}^3 \cdot \text{m}^{-3}$$

where a_0 and a_1 are the calibration coefficients above.

For a generalised mineral soil this becomes:

$$\theta_{\min} = -0.057 - 0.66V + 8.00V^2 - 27.91V^3 + 49.23V^4 - 42.46V^5 + 14.47V^6 \text{ m}^3 \cdot \text{m}^{-3},$$

And for an organic soil:

$$\theta_{\text{org}} = -0.023 - 0.72V + 8.72V^2 - 30.44V^3 + 53.71V^4 - 46.32V^5 + 15.78V^6 \text{ m}^3 \cdot \text{m}^{-3}.$$

Slope and offset conversion

Combining the *Soil calibration* and linear *Profile Probe response* equations:

$$\theta_v \approx \frac{[0.37 + 4.43V] - a_0}{a_1} \text{ m}^3 \cdot \text{m}^{-3}, \text{ up to } 0.3 \text{ m}^3 \cdot \text{m}^{-3}.$$

Using the values of a_0 and a_1 for generalised mineral and organic soils:

From probe V to:	Slope $\text{m}^3 \cdot \text{m}^{-3} / V$	Offset $\text{m}^3 \cdot \text{m}^{-3}$
$\text{m}^3 \cdot \text{m}^{-3}$, Mineral soil	0.528	-0.146
$\text{m}^3 \cdot \text{m}^{-3}$, Organic soil	0.575	-0.121

To convert data readings from volts, multiply by the slope and add the offset. This gives readings in $\text{m}^3 \cdot \text{m}^{-3}$.

Linearisation table conversion

The following table of values is used for the DL2e logger sensor codes P2M, P2O, P2C, P2D.

soil moisture		mineral soil	organic soil
$m^3.m^{-3}$	%vol	Volt	Volt
0	0	0.257	0.177
0.05	5	0.379	0.280
0.10	10	0.497	0.394
0.15	15	0.595	0.501
0.20	20	0.677	0.590
0.25	25	0.749	0.667
0.30	30	0.810	0.734
0.35	35	0.860	0.793
0.40	40	0.899	0.843
0.45	45	0.930	0.882
0.50	50	0.956	0.914
0.55	55	0.977	0.940
0.60	60	0.995	0.962
0.65	65	1.011	0.981
0.70	70	1.026	0.997
0.75	75	1.038	1.012
0.80	80	1.050	1.025
0.85	85	1.060	1.037
0.90	90	1.070	1.048
0.95	95	1.079	1.057
1.00	100	1.088	1.067

DL2e slope and offset conversion

For DL2e data loggers, you can create sensor codes using slope and offset, if you cannot use the linearisation table codes above. These will be accurate only for the restricted range up to 30%vol. The sensor code 'Conversion Factor' is the reciprocal of the 'Slope' figures above. Base units are mV and Engineering units are %vol.

From probe mV to:	Conversion Factor <i>mV/%vol</i>	Offset <i>%vol</i>
%volume, Mineral soil	18.96	-14.6
%volume, Organic soil	17.38	-12.1

Reading accuracy

The *Profile Probe* is accurate and reliable.

However this doesn't guarantee that the readings you take with a PR2 are an accurate measure of the soil moisture. There are three particular sources of error that you need to consider when measuring soil moisture with the *Profile Probe*:

- ◆ **Installation problems**
- ◆ **Soil type and Sampling errors**
- ◆ **Salinity**

Installation problems

An ideal installation would avoid creating either air gaps or soil compaction around the access tube – and then the soil would not shrink or swell as it dried out or rewetted. It's possible to get remarkably close to this ideal in some deeply cultivated soils, and close to impossible in some stony soils or hard clay.

We obviously can't quantify your potential installation errors, but experience suggests that a loose, gappy, access tube installation could lead to errors of $\pm 10\%$ ($\pm 0.1 \text{ m}^3 \cdot \text{m}^{-3}$), so...

- *Take as much care as you can over the installation*
- *Remember to fit a collar to your access tube.*

Soil type and sampling errors

Again, it's not really possible to quantify the potential errors associated with soil type, but be aware of the following:

- *Almost all measurement problems are worst in heavy clay soils.*
- *If your soil cracks badly in dry conditions, the readings from your Profile Probe may be more indicative of crack size than soil moisture content!*
- *The linear relationship in equation [1] is less applicable to heavy clay soils at low soil moisture levels ($< 0.1 \text{ m}^3 \cdot \text{m}^{-3}$). See ref. [7].*
- *Soil moisture content may vary significantly even within a small volume of soil. When you rotate the Profile Probe within its access tube the reading changes you observe reflect real soil moisture variability.*

Salinity

Changes in soil salinity cause a change in reading, which will appear as a change in soil moisture. Typical effects on *Profile*

Probe readings are an apparent change of $< 0.005 \text{ m}^3 \cdot \text{m}^{-3}$ soil moisture for a change of $100 \text{ mS} \cdot \text{m}^{-1}$ soil salinity.

In most situations this sensitivity is of little significance because a change of $100 \text{ mS} \cdot \text{m}^{-1}$ is very unlikely - but it may need to be considered particularly when irrigating with saline irrigation water.

See **Salinity Performance** in the **Technical Reference** section.

Troubleshooting

Problems

When getting problems from a probe or sensor always try to identify which part of the measurement system is the source of the difficulty. For the *Profile Probe* this may fall into one of the following areas:

The measurement device

What equipment is being used to read the probe output?

- An HH2 Moisture Meter
- A DL6 logger
- A DL2e logger
- A GP2 logger

Consult the user manuals or the on-line help for these devices, and their related software.

Try alternative types of equipment if you have them available.

Check that the soil calibration being used is appropriate for your soil, and that the correct conversion method is being used – see **Calibration** section.

The probe itself

Try to isolate the problem into one of the following areas

- The Probe or the connecting cable

Then try to narrow down the area further

- Mechanical problems faults, or damage
- Electrical or electronic problems or faults

Calibration check

We recommend that you check the calibration of your PR2 at least once a year by taking an air reading and a water reading as follows:

Air reading

Keep the PR2 in its protection tube and hold it away from any other objects. Take a reading using an HH2 meter, or other meter or logger. The reading should be $75 \pm 20\text{mV}$.

Water reading

Insert the PR2 fully into an access tube and immerse them into a large body of water at 20 to 25°C. The water container should be sufficiently large so that the PR2 is >100mm from any edge. Take a reading using an HH2 meter, or other meter or logger. Although this reading is outside the PR2's specified accuracy range, the reading should lie between 1040 and 1100mV.

Centring springs

Check that the centring springs are all fitted, clean and undamaged. Immediately replace any that do become damaged.

Installation problems

Augering and access tube insertion

Most PR2 errors are caused by inserting an access tube into the wrong size of Augered hole.

If the hole is too large, gaps around the tube will result in generally low readings and poor response to soil moisture changes – unless the gaps fill with rainwater.

If the Augered hole is too small, the effort necessary to hammer the access tube into the soil will often result in gaps forming around the tube at the top and compaction of the soil lower down the tube.

Refer to the Augering Manual for advice on Augering holes of the correct size.

See also the video at

<https://youtube.com/watch?v=KvZC2-xYDL8>

Technical reference

Specifications

Technical Specifications for PR2/4 and PR2/6	
Measurement	Volumetric soil moisture content, θ_v ($\text{m}^3.\text{m}^{-3}$ or %vol.).
Range	Accuracy specified from 0 to $0.4 \text{ m}^3.\text{m}^{-3}$, Full range is from 0.0 to $1.0 \text{ m}^3.\text{m}^{-3}$
Accuracy	$\pm 0.04 \text{ m}^3.\text{m}^{-3}$, 0 to 40°C after soil specific calibration
	$\pm 0.06 \text{ m}^3.\text{m}^{-3}$, 0 to 40°C with generalised soil calibration in 'normal' soils
Salinity errors	Included in above figures (50 to $400 \text{ mS}.\text{m}^{-1}$)
Soil sampling volume	Vertically: $\sim 95\%$ sensitivity within $\pm 50\text{mm}$ of upper ring of each pair. Horizontally: $\sim 95\%$ sensitivity within a cylinder of radius 100mm .
Environment	0 to 40°C for full accuracy specification, -20 to 60°C full operating range. IP67 rated
Stabilisation	Full accuracy achieved within 1s from power-up.
Power requirement	Minimum: 5.5V DC with 2m cable, 7.0V with 100m .* Maximum: 15V DC PR2/4 consumption: $< 80 \text{ mA}$ PR2/6 consumption: $< 120 \text{ mA}$
Outputs	4 (PR2/4) or 6 (PR2/6) analogue voltage outputs: ~ 0 to 1.0V DC corresponding to $0 - 0.6 \text{ m}^3.\text{m}^{-3}$ (mineral calibration)
Connector	M12 8-way male.
Cabling	Up to 100m of cabling may be attached
Construction material	25.4mm polycarbonate tube with pairs of stainless steel rings
Size / weight	PR2/4 length: 750mm Weight: 0.6kg
	PR2/6 length: 1350mm Weight: 0.95kg

*using cables supplied by ΔT

Performance

Field sensitivity

The signal is applied across each pair of rings, but the electromagnetic field is strongest around the lower ring. This field extends a considerable distance into the soil (~100mm), but it is strongest close to the rings, and so the soil close to the rings contributes most to the output.

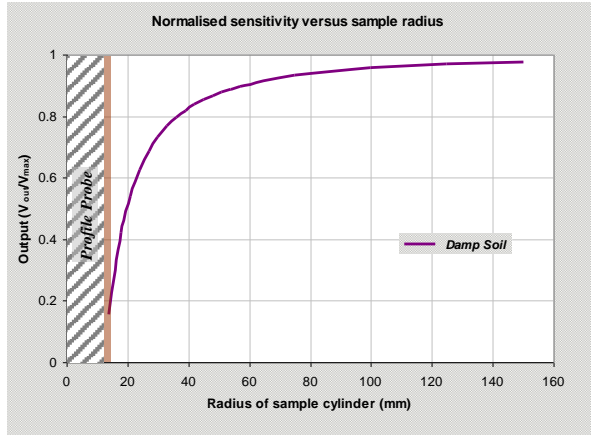

Salinity

The Profile Probe output has been tested as follows:

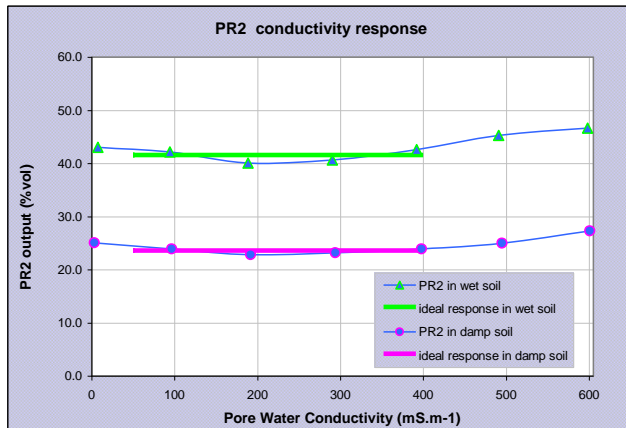

Temperature

The *Profile Probe* has a very low intrinsic sensitivity to changes in temperature, as in this example:

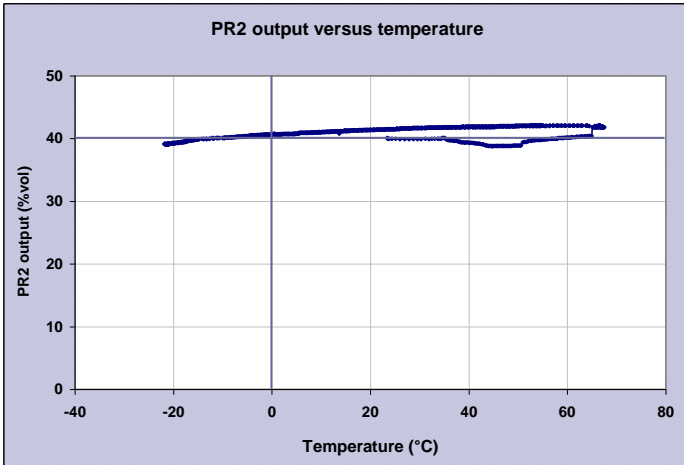

This relationship is dependent on soil composition (particularly clay content) and the soil moisture level, see ref. [7].

Electromagnetic Compatibility (EMC)

Europe

The *Profile Probe* has been assessed for compatibility under the European Union EMC Directive 89/336/EEC and conforms to the appropriate standards, provided the probe body and moisture measuring rings are completely inserted into the access tube within the soil or other material being measured. The cable connecting the *Profile Probe* to its associated instrumentation should be routed along the surface of the soil.

If the probe is not installed in this way, some interference may be experienced on nearby radio equipment. Under most conditions, moving the equipment further from *Profile Probe* (typically 1-2 metres) will stop the interference.

Profile Probes installed near to each other will not malfunction due to interference.

FCC Compliance North America

This device complies with Part 18 of the FCC Rules. Operation is subject to the following two conditions:
(1) this device may not cause harmful interference, and
(2) this device must accept any interference received, including interference that may cause undesired operation

Definitions

Volumetric Soil Moisture Content is defined as

$$\theta_V = \frac{V_W}{V_S}$$

where V_W is the volume of water contained in the sample
and V_S is the total volume of the soil sample.

The preferred units for this ratio are $\text{m}^3 \cdot \text{m}^{-3}$, though **%vol** is frequently used.

Soil Moisture Content varies from approx. $0.02 \text{ m}^3 \cdot \text{m}^{-3}$ for sandy soils at the permanent wilting point, through approx. $0.4 \text{ m}^3 \cdot \text{m}^{-3}$ for clay soils at their field capacity, up to values as high as $0.85 \text{ m}^3 \cdot \text{m}^{-3}$ in saturated peat soils.

Gravimetric Soil Moisture Content is defined as

$$\theta_G = \frac{M_W}{M_S} \quad \text{g} \cdot \text{g}^{-1}$$

where M_W is the mass of water in the sample,
and M_S is the total mass of the **dry**

sample.

To convert from volumetric to gravimetric water content, use the equation

$$\theta_G = \theta_V \cdot \frac{\rho_W}{\rho_S}$$

where ρ_W is the density of water ($= 1$),
and ρ_S is the bulk density of the sample ($= \frac{M_S}{V_S}$).

Organic and Mineral definitions:

The generalised calibrations have been optimised to cover a wide range of soil types, based on the following definitions:

Soil type	optimised around organic content:	use for organic contents:	bulk density range: ($\text{g} \cdot \text{cm}^{-3}$)	use for bulk densities: ($\text{g} \cdot \text{cm}^{-3}$)
Mineral	~ 1 %C	< 7 %C	1.25 - 1.5	> 1.0
Organic	~ 40 %C	> 7 %C	0.2 - 0.7	< 1.0

Salinity

The preferred SI units for ionic conductivity are **mS.m⁻¹** (where S is Siemens, the unit of electric conductance = ohm⁻¹).

The following conversions apply:

$$\begin{aligned} 1 \text{ mS.m}^{-1} &= 0.01 \text{ dS.m}^{-1} \\ &= 0.01 \text{ mS.cm}^{-1} \\ &= 0.01 \text{ mmho.cm}^{-1} \\ &= 10 \text{ }\mu\text{S.cm}^{-1} \end{aligned}$$

Soil salinity is also partitioned into the following descriptive categories:

non-saline	0 - 200	mS.m ⁻¹
slightly saline	200 - 400	mS.m ⁻¹
moderately saline	400 - 800	mS.m ⁻¹
strongly saline	800 - 1600	mS.m ⁻¹
extremely saline	> 1600	mS.m ⁻¹

References

1. Gaskin, G.J. and J.D. Miller, 1996
Measurement of soil water content using a simplified impedance measuring technique.
J. Agr. Engng Res **63**, 153-160
2. Topp, G.C., J. L. Davis and A. P Annan 1980
Electromagnetic determination of soil water content.
Water Resour. Res **16**(3) 574-582
3. Whalley, W.R. 1993
Considerations on the use of time-domain reflectometry (TDR) for measuring soil moisture content.
Journal of Soil Sci. **44**, 1-9
4. White, I., J.H. Knight, S.J. Zegelin, and Topp, G.C. 1994
Comments on 'Considerations on the use of time-domain reflectometry (TDR) for measuring soil water content' by W R Whalley
Journal of Soil Sci. **45**, 503-508
5. Roth, C.H., M.A. Malicki, and R. Plagge, 1992
Empirical evaluation of the relationship between soil dielectric constant and volumetric water content as the basis for calibrating soil moisture measurements.
Journal of Soil Sci. **43**, 1-13
6. Knight, J.H. 1992
Sensitivity of Time Domain Reflectometry measurements to lateral variations in soil water content.
Water Resour. Res., **28**, 2345-2352
7. Or, D. and J.M. Wraith 1999
Temperature effects on soil bulk dielectric permittivity measured by time domain reflectometry: A physical model.
Water Resour Res., **35**, 371-383
8. Whalley, W.R., R.E. Cope, C.J. Nicholl, and A.P. Whitmore, 2004
In-field calibration of a dielectric soil moisture meter designed for use in an access tube.
Soil Use and Management, **20**, 203-206

Technical Support

Terms and Conditions of Sale

Our Conditions of Sale (ref: COND: 1/07) set out Delta-T's legal obligations on these matters. The following paragraphs summarise Delta T's position but reference should always be made to the exact terms of our Conditions of Sale, which will prevail over the following explanation.

Delta-T warrants that the goods will be free from defects arising out of the materials used or poor workmanship for a period of twelve months from the date of delivery.

Delta-T shall be under no liability in respect of any defect arising from fair wear and tear, and the warranty does not cover damage through misuse or inexpert servicing, or other circumstances beyond their control.

If the buyer experiences problems with the goods they shall notify Delta-T (or Delta-T's local distributor) as soon as they become aware of such problem.

Delta-T may rectify the problem by replacing faulty parts free of charge, or by repairing the goods free of charge at Delta-T's premises in the UK during the warranty period.

If Delta-T requires that goods under warranty be returned to them from overseas for repair, Delta-T shall not be liable for the cost of carriage or for customs clearance in respect of such goods. However, Delta-T requires that such returns are discussed with them in advance and may at their discretion waive these charges.

Delta-T shall not be liable to supply products free of charge or repair any goods where the products or goods in question have been discontinued or have become obsolete, although Delta-T will endeavour to remedy the buyer's problem.

Delta-T shall not be liable to the buyer for any consequential loss, damage or compensation whatsoever (whether caused by the negligence of the Delta-T, their employees or distributors or otherwise) which arise from the supply of the goods and/or services, or their use or resale by the buyer.

Delta-T shall not be liable to the buyer by reason of any delay or failure to perform their obligations in relation to the goods and/or services if the delay or failure was due to any cause beyond the Delta-T's reasonable control.

Service, Repairs and Spares

Users in countries that have a Delta-T distributor or technical representative should contact them in the first instance.

Spare parts for our own instruments can be supplied and can normally be despatched within a few working days of receiving an order.

Spare parts and accessories for products not manufactured by Delta-T may have to be obtained from our supplier, and a certain amount of additional delay is inevitable.

No goods or equipment should be returned to Delta-T without first obtaining the return authorisation from Delta-T or our distributor.

On receipt of the goods at Delta-T you will be given a reference number. Always refer to this reference number in any subsequent correspondence. The goods will be inspected and you will be informed of the likely cost and delay.

We normally expect to complete repairs within one or two weeks of receiving the equipment. However, if the equipment has to be forwarded to our original supplier for specialist repairs or recalibration, additional delays of a few weeks may be expected. For contact details see below.

Technical Support

Users in countries that have a Delta-T distributor or technical representative should contact them in the first instance.

Technical Support is available on Delta-T products and systems. Your initial enquiry will be acknowledged immediately with a reference number. Make sure to quote the reference number subsequently so that we can easily trace any earlier correspondence.

In your enquiry, always quote instrument serial numbers, software version numbers, and the approximate date and source of purchase where these are relevant..

Contact details:

Tech Support Team
Delta-T Devices Ltd
130 Low Road, Burwell, Cambridge CB25 0EJ, U.K.
email: tech.support@delta-t.co.uk
email: repairs@delta-t.co.uk
web: www.delta-t.co.uk
Tel: +44 (0) 1638 742922
Fax: +44 (0) 1638 743155

Appendix A

Soil-specific calibration

This note provides details of 3 techniques for generating soil-specific calibrations:

1. *Laboratory calibration for substrates* and non-clay soils*
2. *Laboratory calibration for clay soils*
3. *Field calibration*

* We use the term substrate to refer to any artificial growing medium.

Underlying principle

Soil moisture content (θ) is proportional to the refractive index of the soil ($\sqrt{\epsilon}$) as measured by the ThetaProbe and *Profile Probe* (see **Calibration** section).

The goal of calibration is to generate two coefficients (a_0, a_1) which can be used in a linear equation to convert probe readings into soil moisture:

$$\sqrt{\epsilon} = a_0 + a_1 \times \theta$$

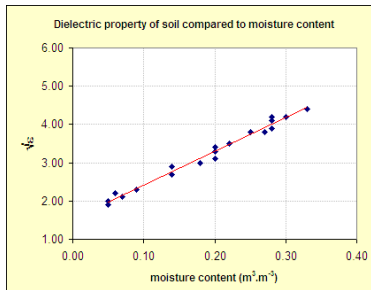

Using the ThetaProbe to calibrate the Profile Probe

Soil calibrations using the ThetaProbe and *Profile Probe* are very similar - because they measure the same fundamental dielectric property ($\sqrt{\epsilon}$) at the same frequency (100MHz). However both their calibrations are influenced by their slight sensitivity to conductivity - and they differ in how this sensitivity changes with water content. The ThetaProbe (and methods 1. or 2. below) can be used effectively for creating soil-specific Profile Probe calibrations at low water contents and/or low conductivities. At high conductivity *and* high water content it is far better to generate *Profile Probe* calibrations using the field calibration technique (3.).

Laboratory calibration non-clay soils

This is the easiest technique, but it's not suitable for soils that shrink or become very hard when dry.

Equipment you will need:

- ML3 and volt meter
- Soil corer (if doing a calibration for a cohesive soil rather than sand or a substrate)
- Heat-resistant beaker ($\geq 500\text{ml}$)
- Weighing balance (accurate to $< 1\text{g}$)
- Temperature controlled oven (for mineral soils or substrates)

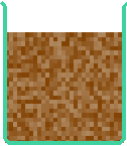
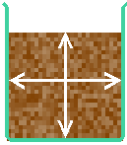
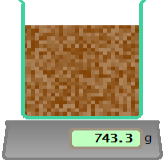
Process	Notes and example
	<p>Collect a damp sample of the soil or substrate. This sample needs to be unchanged from its in-situ density, to be $\geq 500\text{ml}$, to have the correct dimensions to fit the beaker, and to be generally uniform in water content.</p> <p>For cohesive soils this is most easily done with a soil-corer.</p> <p>Sandy soils can be poured into the beaker, but you should take the subsequent measurements immediately, as the water will quickly begin to drain to the bottom of the beaker.</p> <p>Compressible soils and composts often require measurement of the in-situ density and then need to be carefully reconstituted at that density within the beaker.</p>
	<p>Measure the volume occupied by the sample. $L_s = 463.5 \text{ ml}$</p>
	<p>Weigh the sample, including the beaker. $W_w = 743.3 \text{ g}$</p>

Appendix A

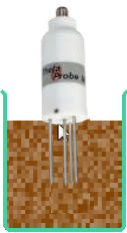
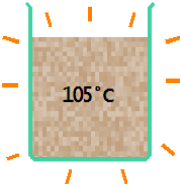
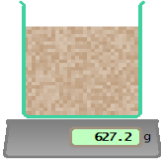
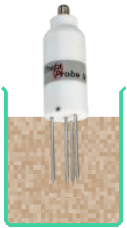
	<p>Insert ML3 into the sample and record its output in Volts.</p> <p>$V_w = 0.672 V$</p>
	<p>Dry the sample thoroughly.</p> <p>With mineral soils this is usually achieved by keeping it in the oven at 105°C for several hours or days (the time required depends on the sample size and porosity).</p> <p>For organic soils and composts it's usual to air-dry the sample to avoid burning off any volatile fractions.</p>
	<p>Weigh the dry sample in the beaker.</p> <p>$W_0 = 627.2 g$</p>
	<p>Re-insert the ML3 into the dry sample and record this reading.</p> <p>$V_0 = 0.110 V$</p>
<p>Calculate a_0</p>	<p>In the dry soil $V = V_0 = 0.089$ Volts Substitute this into the ML3 equation</p> $\sqrt{\epsilon} = 1.0 + 6.175V + 6.303V^2 - 73.578V^3 + 183.44V^4 - 184.78V^5 + 68.017V^6$ <p>gives $\sqrt{\epsilon_0} = 1.56$</p> <p>Since $\theta_0 = 0$, this is the value needed for a_0</p> <p>$a_0 = 1.56$</p>

Appendix A



Calculate θ_w	<p>The water content of the wet soil, θ_w, can be calculated from the weight of water lost during drying, $(W_w - W_0)$ and its volume, L_s:</p> $\theta_w = (W_w - W_0) / L_s = (743.3 - 627.2) / 463.5 = 0.25$ <p>$\theta_w = 0.25$</p>
Calculate a_1	<p>In the wet soil $V = V_w = 0.572$ Volts and substituting gives $\sqrt{\varepsilon_w} = 3.53$</p> <p>Finally</p> $a_1 = (\sqrt{\varepsilon_w} - \sqrt{\varepsilon_0}) / (\theta_w - \theta_0) = (3.53 - 1.56) / (0.25 - 0) = 7.87$ <p>$a_1 = 7.87$</p>
Result	<p>$a_0 = 1.56$</p> <p>$a_1 = 7.87$</p>

Laboratory calibration for clay soils

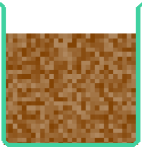
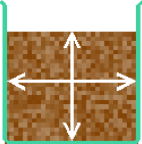
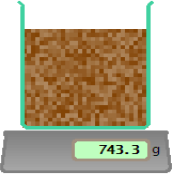

This technique is adapted to avoid the near-impossibility of inserting the ThetaProbe into a completely dry clay soil. It requires taking measurements at 2 significantly different, but still damp, moisture levels.

Equipment you will need:

- ML3 and volt meter
- Soil corer
- Heat-resistant beaker (≥ 500 ml)
- Weighing balance (accurate to < 1 g)
- Temperature controlled oven

Process	Notes and example
	<p>Collect a <u>wet</u> sample of the clay soil: 25 to 30% water content would be ideal.</p> <p>This sample needs to be unchanged from its in-situ density, to be ≥ 500ml, to have the correct dimensions to fit the beaker, and to be generally uniform in water content.</p> <p>This is most easily done with soil-corer.</p>
	<p>Measure the volume occupied by the sample.</p> <p>$L_s = 463.5$ ml</p>
	<p>Weigh the wet sample, including the beaker.</p> <p>$W_w = 743.3$ g</p>
	<p>Insert ML3 into the wet sample and record its output in Volts.</p> <p>$V_w = 0.572$ V</p>

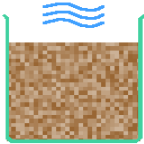
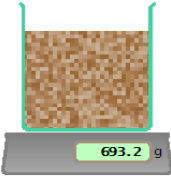
Appendix A

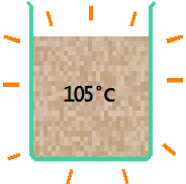
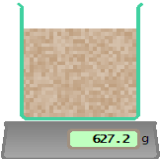
	<p>Dry the sample until still moist, ~15% water content. Gentle warming can be used to accelerate the process, but take care not to over-dry in places, and allow time for the water content to equilibrate throughout the sample before taking a reading.</p>
	<p>Reweigh. $W_m = 693.2 \text{ g}$</p>
	<p>Re-measure with the ML3. $V_m = 0.348 \text{ V}$</p>
	<p>Dry the sample thoroughly. With mineral soils this is usually achieved by keeping it in the oven at 105°C for several hours or days (the time required depends on the sample size and porosity).</p>
	<p>Weigh the dry sample in the beaker. $W_o = 627.2 \text{ g}$</p>
<p>Calculations</p>	<p>Substituting in the ML2 equation</p> $\sqrt{\epsilon} = 1.0 + 6.175V + 6.303V^2 - 73.578V^3 + 183.44V^4 - 184.78V^5 + 68.017V^6$ <p>provides two dielectric values, $\sqrt{\epsilon_w}$ and $\sqrt{\epsilon_m}$, at two known water contents, θ_w and θ_m:</p>
<p>For the wet soil</p>	<p>Substituting $V_w = 0.572$ gives</p> $\sqrt{\epsilon_w} = 3.53 = a_0 + a_1 \cdot \theta_w$

Appendix A

	for $\theta_w = (743.3 - 627.2)/463.5 = 0.25$
For the moist soil	Substituting $V_m = 0.348$ gives $\sqrt{\varepsilon_m} = 2.68 = a_0 + a_1 \cdot \theta_m$ For $\theta_m = (693.2 - 627.2)/463.5 = 0.14$
Calculate a_1	Then $a_1 = (\sqrt{\varepsilon_w} - \sqrt{\varepsilon_m})/(\theta_w - \theta_m) = 7.86$ $a_1 = 7.86$
Calculate a_0	and $a_0 = \sqrt{\varepsilon_w} - (a_1 \cdot \theta_w) = 1.56$ $a_0 = 1.56$
Result	$a_1 = 7.86$ $a_0 = 1.56$

In this example this soil is now calibrated.

You can now use these two numbers in place of the standard mineral or organic calibration factors to convert PR2 readings into volumetric water content θ using:

$$\sqrt{\varepsilon} = a_0 + a_1 \times \theta$$

Field calibration

Field calibration is the surest method of calibration. We strongly recommend it for *Profile Probe* installations featuring high water content (usually high-clay-content) and high conductivity, as it is the only technique likely to give good results. However it is typically far more time consuming and requires access to considerably more equipment than laboratory calibration.

General principle

Install access tubes and take *Profile Probe* measurements (as voltages) over a period of time when the soil moisture content is changing. Over the same period, measure the water content at appropriate depths and spacing around the access tubes either by gravimetric sampling or using a Neutron Probe or an ML3. These comparison readings can then be used to construct a calibration for the *Profile Probe*.

For best results this approach requires comparison readings over a significant range of soil moisture contents. If the changes in water content over the measurement period are small, the calibration becomes very sensitive to any measurement errors. The extreme case of this occurs when readings are only available at a single soil moisture content. It is still possible to calibrate the *Profile Probe* in these cases - by assuming a default value for the intercept coefficient, a_0 .

Equipment you will need:

- Installed *Profile Probe* access tubes, and *Profile Probe* with either meter or data logger
- Either **installed ML3s**, ~150mm from the access tubes at the appropriate depth

Or **Neutron Probe** access tubes installed ~300mm from the Profile Probe tubes

Or **gravimetric sampling** equipment (see previous methods)

Or a **portable ML3** attached to a suitable length extension rod and a suitable auger for sampling at depth

The gravimetric and portable ML3 methods both require essentially destructive measurements, which limit their re-use at the same site, so they may require a number of similar sites. But see below for fixed intercept calibration.

Appendix A

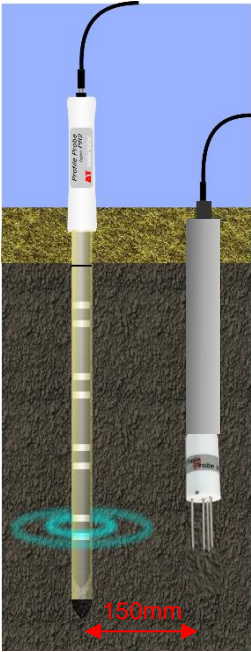
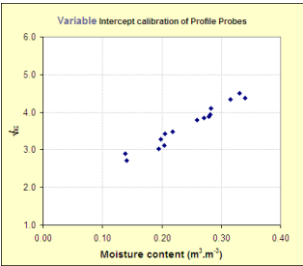
Process	Notes and example						
	<p>Take <i>Profile Probe</i> readings (as voltages) over a period of time as the soil moisture content changes. Ideally this would include 3 or more distinct soil moisture levels covering a change > $0.1\text{m}^3\cdot\text{m}^{-3}$.</p> <p>At the same time, take several independent soil moisture readings spaced around the <i>Profile Probe</i> access tube. These could be taken either with ML3s or a Neutron Probe or by gravimetric sampling.</p> <p>The number of samples required depends on the uniformity of the soil and the size of the sampling volume.</p> <p>If it is difficult to take readings over a range of moisture levels, it is still possible to calibrate the <i>Profile Probe</i> using a single soil moisture comparison using the fixed intercept method below.</p>						
<table border="1" data-bbox="165 842 415 970"> <thead> <tr> <th>V</th> <th>$\rightarrow \sqrt{\epsilon}$</th> </tr> </thead> <tbody> <tr> <td>0.462</td> <td>2.31</td> </tr> <tr> <td>0.577</td> <td>2.78</td> </tr> </tbody> </table>	V	$\rightarrow \sqrt{\epsilon}$	0.462	2.31	0.577	2.78	<p>Convert the <i>Profile Probe</i> measurements into $\sqrt{\epsilon}$ using its calibration equation [2].</p>
V	$\rightarrow \sqrt{\epsilon}$						
0.462	2.31						
0.577	2.78						
	<p>Graph these $\sqrt{\epsilon}$ readings against the soil moisture measurements.</p> <p>(This illustration and the following procedures are taken from Excel, but the principles can also be applied within other graphing or spreadsheet programs)</p>						

Appendix A

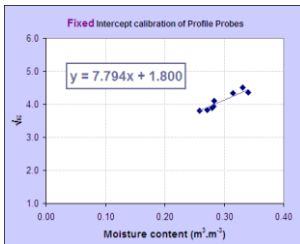
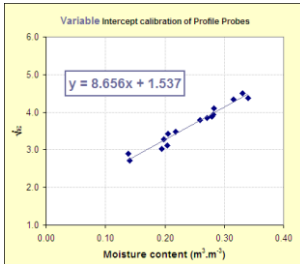

Variable Intercept

Fit a linear trend line to the data, and in the Options tab choose to display the equation. You may need to adjust the number format for the equation to 3 decimal places.

The calibration coefficients can then be read off directly. In the example shown, $a_0 = 1.537$ and $a_1 = 8.656$.

Fixed Intercept

Fit a linear trend line as above, but in the Options also choose "Set intercept =".

We suggest you use the following default intercept values:

Organic soil	1.4
Mineral soil	1.6
Heavy clay	1.8

In this example the intercept has been set to $a_0 = 1.8$, and the calculated value for $a_1 = 7.794$.

Index

A

Access tube, 4, 6, 7, 9, 10, 12,
14, 24, 26, 30, 32, 35, 45, 46

bung, 6

cap, 6, 7, 12, 14

Accuracy, 26, 30

Air gaps, 9, 26

C

Calibration, 14, 21, 22, 24, 30,
35, 38, 39, 42, 45, 46, 47

soil-specific, 22, 38

**Cleaning and Chemical
Avoidance Instructions**, 8

Connections, 17, 18, 20

Conversion factor, 25

Conversions, 20, 22, 23, 25

linearisation table, 22, 23, 25

polynomial, 23

slope and offset, 21, 22, 23,
24, 25

D

Data logger, 6, 15, 17, 19, 20,
23, 25, 45

DL2e, 6, 17, 18, 19, 20, 25

DL6, 6, 15, 16

Data Logger options, 15

Definitions, 33

Dielectric performance, 23, 35,
38, 43

E

EMC, 32

F

FCC, 32

Field sensitivity, 31

G

GP2 Logger, 20

H

HH2 meter, 14

I

Installation, 4, 10, 18, 22, 26

M

Moisture content, 4, 9, 23, 26,
30, 35, 38, 45, 46

P

Power requirement, 30

Power supply, 9, 17, 18, 19, 20,
30

R

Range, 30

References, 35

S

Salinity, 26, 27, 30, 31, 34

Sampling

volume, 4, 14, 30, 46

Soil

clay, 21, 22, 26, 32, 33, 38, 39,
42, 45, 47

composition, 32

dry, 26, 39

mineral, 18, 22, 24, 25, 30, 40,
43

organic, 18, 21, 22, 24, 25, 33,
40

type, 14, 26

Specifications, 30